

### Using Your Setup Instructions

The Aero Setup Instructions are created specifically for your configuration. The instructions include an exploded view of the frame which is sequentially labeled. We encourage you to review the instructions before attempting to assemble your exhibit.

Connections are kept very simple; no tools required. Everything assembles with push-button connectors.

### Cleaning and Packing Your Display

- 1) Use care when cleaning aluminum extrusion or acrylic inserts. Use only non-abrasive cleaners.
- 2) Retain all packing material. It will make re-packing much easier and will reduce the likelihood of shipping damage.

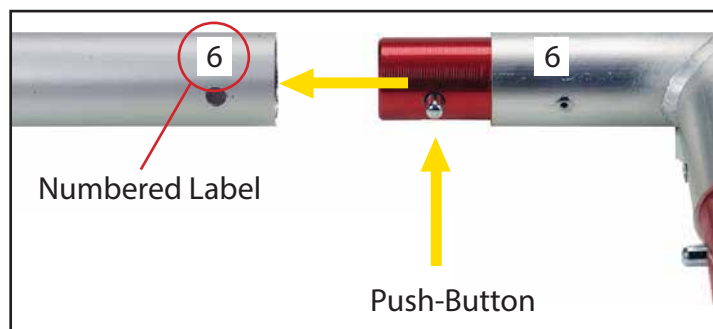

Connections are made by holding the button down and sliding the red tube into opposing tube until button locks into the hole. To disassemble, push button and pull or twist extrusions apart.

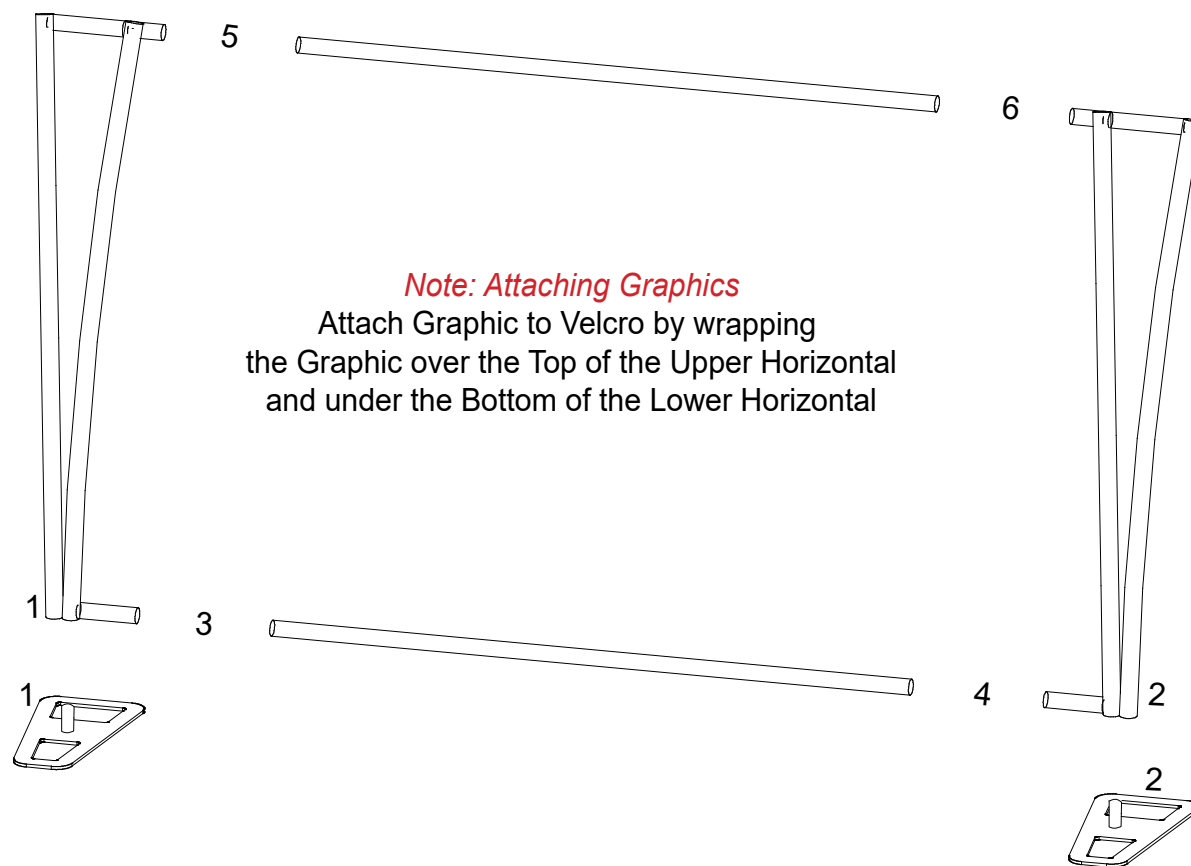
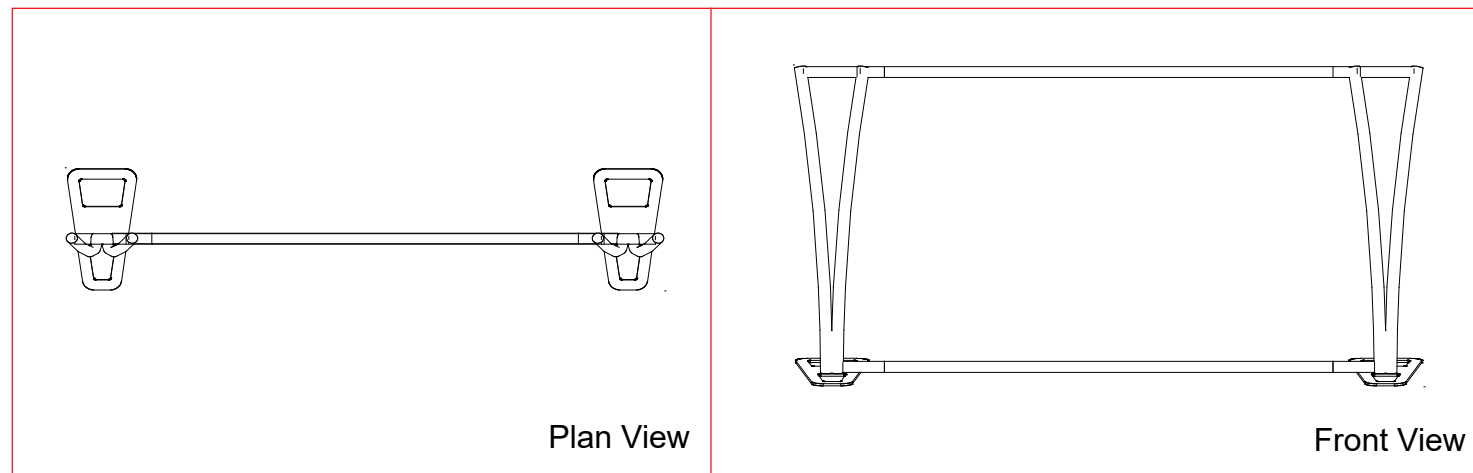
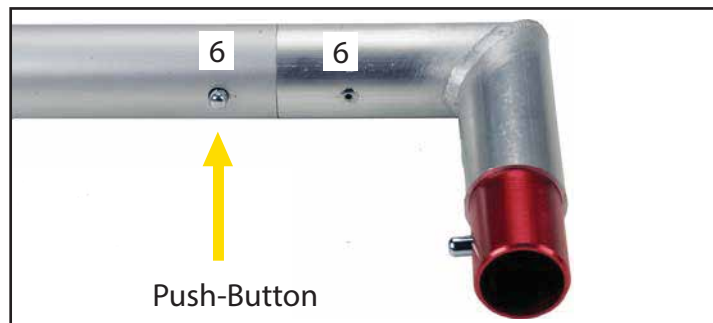

- Steps:
- 1) Attach Base Plates 1 and 2 to verticals 1 and 2 as shown.
  - 2) Assemble pieces 3 thru 6 together as shown.

# SETUP INSTRUCTIONS